

# VC Series Unpowered I/O Expansion Modules User Manual

Thank you for purchasing the I/O expansion module developed and produced by Suzhou VEICHI Electric Technology Co., Ltd. please read this manual carefully before using our VC series PLC products, so as to better grasp the characteristics of the products and install and use them correctly. More secure application and make full use of the rich functions of this product.

## Tips:

Please read the operating instructions, precautions and cautions carefully before starting to use the product in order to reduce the risk of accidents. Personnel responsible for the installation and operation of the product must be strictly trained to comply with the safety codes of the relevant industry, strictly observe the relevant equipment precautions and special safety instructions provided in this manual, and carry out all operations of the equipment in accordance with the correct operating methods.

## 1 Product introduction

### 1.1 Shape structure

The form factor of the I/O expansion module is shown in the diagram below.

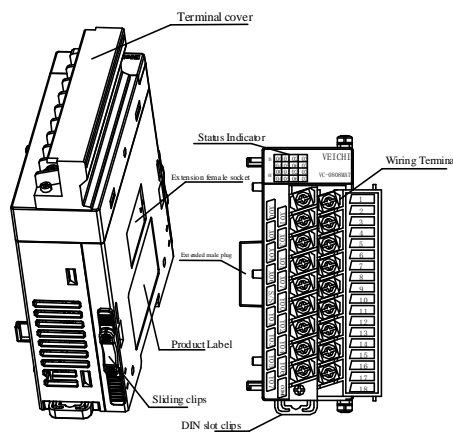

Figure 1-1 I/O expansion module form factor and components

### 1.2 Model description

The product model description is shown in Figure 1-2.

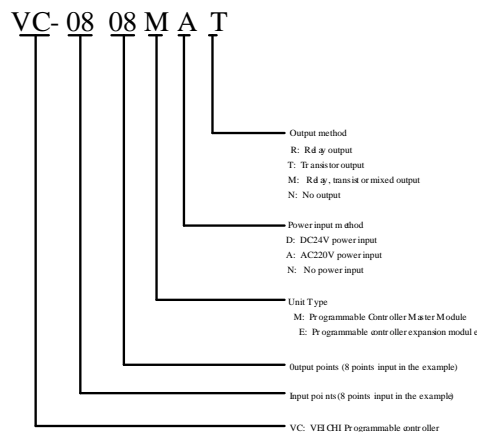

Figure 1-2 PLC model description

### 1.3 Extended I/O module class appearance diagram

VC-0808ENR Expansion Module External and Terminal Diagram

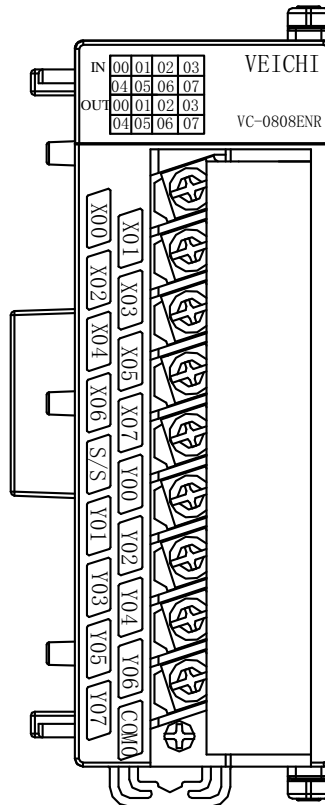

Figure 1-3 VC-0808ENR external appearance and terminal diagram

VC-0808ENT expansion module appearance and terminal diagram

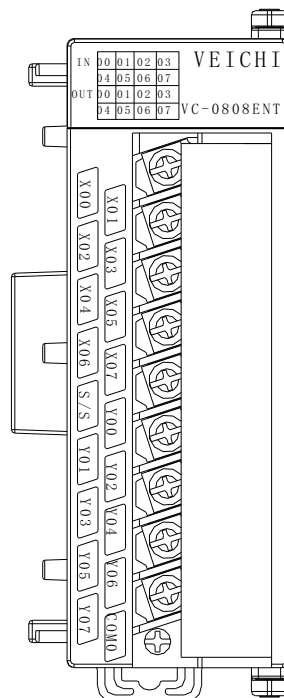

Figure 1-4 VC-0808ENT appearance and terminal diagram

VC-0016ENT Expansion Module External and Terminal Diagram

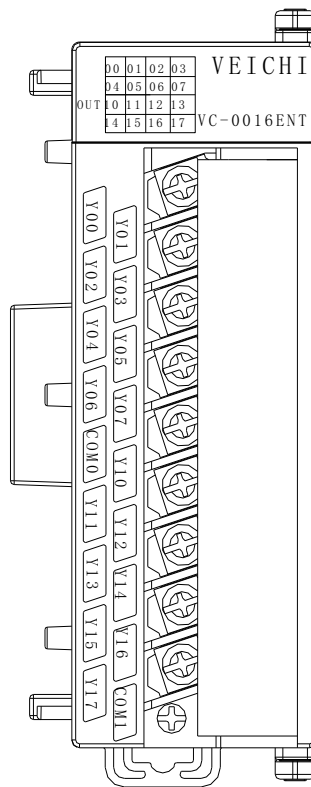

Figure 1-5 VC-0016ENT appearance and terminal diagram

VC-0016ENR Expansion Module External and Terminal Diagram

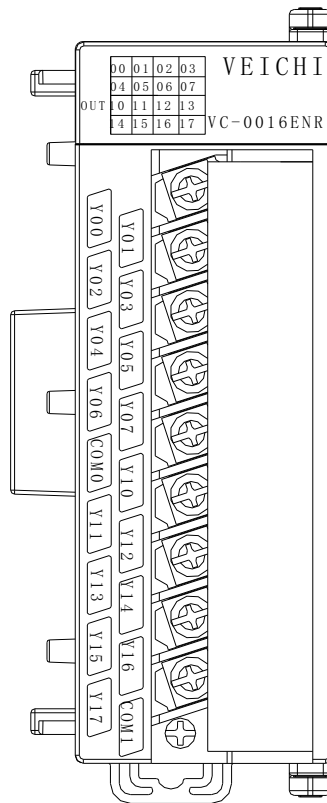

Fig. 1-6 VC-0016ENR external and terminal diagram

## VC-1600ENN expansion module appearance and terminal diagram

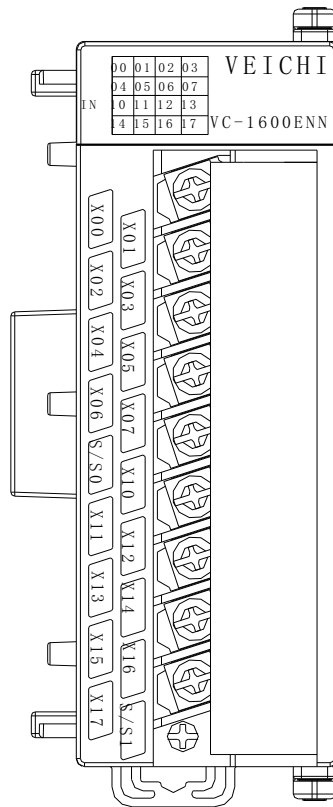

Figure 1-7 VC-1600ENN Outline and Terminal Diagram

### 1.4 Definition of terminals

#### (1) VC-0808ENR、VC-0808ENT

Pin identification	Function description
S/S	Provides the user with a choice of input methods, with a connection to +24V indicating support for the drain input method and a connection to COM indicating support for the source input method
X0~X7	Switching signal input terminals
Y0~Y7、COM0	Control output terminals

#### (2) VC-0016ENR、VC-0016ENT

Pin identification	Function description
Y0~Y7、COM0 Y10~Y17、COM1	Control output terminals

#### (3) VC-1600ENN

Pin identification	Function description
S/S	Provides the user with a choice of input methods, with a connection to +24V indicating support for the drain input method and a connection to COM indicating support for the source input method
X0~X7、X10~X17	Switching signal input terminals

## 2 Product specification

Table 2-1 I/O expansion module types and configuration

Model	Supply voltage Vac	Number of input/output points	Type of output
VC-0808ENR	/	8/8	Relay
VC-0808ENT	/	8/8	Transistor
VC-1600ENN	/	16/0	/
VC-0016ENR	/	0/16	Relay
VC-0016ENT	/	0/16	Transistor

Table 2-2 Electrical insulation specifications for I/O expansion modules

Name	Test conditions
User output (relay type) to extension bus	Able to withstand 50Hz, 2830Vac AC voltage or equivalent DC voltage for 1 minute without breakdown or arcing; leakage current $\leq 5\text{mA}$
User input to user output (relay type)	Able to withstand 50Hz, 2830Vac AC voltage or equivalent DC voltage for 1 minute without breakdown or arcing; leakage current $\leq 5\text{mA}$
User input port and expansion bus	按 Design for ultra-low voltage circuit requirements

Table 2-3 I/O expansion module power requirements

Model	5Vdc/GND	24Vdc/GND	Remark
VC-0808ENR	68mA	115mA	
VC-0808ENT	115mA	50mA	
VC-1600ENN	70mA	95mA	
VC-0016ENR	70mA	125mA	
VC-0016ENT	150mA	0mA	
Remarks.			
1. 5Vdc/GND: The logic circuit of the expansion module is supplied by the expansion bus.			
2. 24Vdc/GND: The relay circuit of the expansion module is powered by the expansion bus.			

Before the extension module is connected to the main module, the sum of the current consumed by each power supply of the extension module must be calculated to ensure that the current of each power supply is less than the output current that can be provided by the corresponding power supply of the main module to avoid overloading the power supply of the main module.

## 3 Input characteristics

### 3.1 Internal equivalent input circuit

The I/O expansion module requires external access to the user's switch state detection power supply (24 Vdc), the internal equivalent resistance of the input circuit is about 4.3 k $\Omega$ , the detection of the signal uses a bidirectional optocoupler, the user can use the source type or the drain type, only the access to the dry contact switch signal is required. The internal equivalent power supply and input signal wiring of the I/O expansion module is similar to the input circuit of the main module, as shown in Figure 3-1.

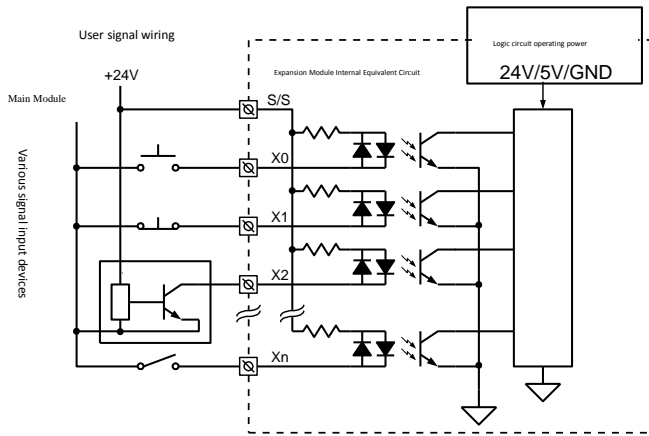

Figure 3-1 I/O expansion module internal equivalent input circuit

Figure 3-1 I/O expansion module internal equivalent input circuit

### 3.2 Input and output signal status indication

The user input terminal status can be indicated by the input terminal status LED, which is lit when the input port is closed (ON state), otherwise it is off.

The status of the output port is indicated by the output status LED, when the output port is closed (ON state) (closed state between  $Y_n$  and  $COM_n$ ), the indicator lights up, otherwise the indicator goes out, as shown in Figure 3-2.

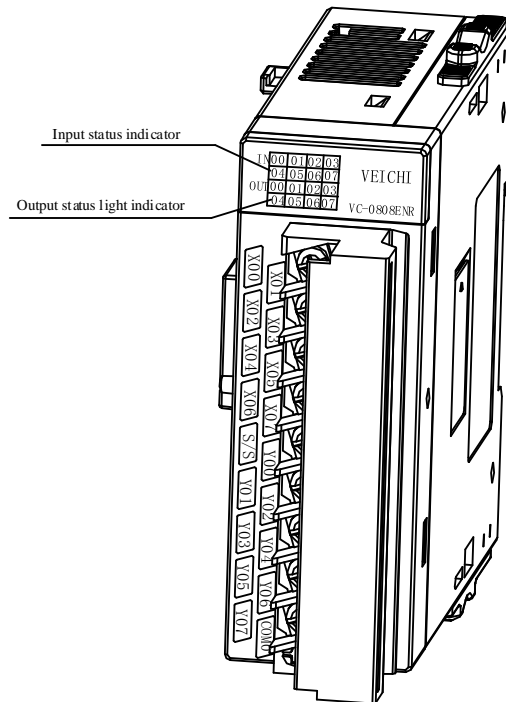

Figure 3-2 I/O expansion module status indicators

## 4 Output characteristics

### 4.1 Electrical specification for relay type output ports

Table 4-1 Electrical specifications for relay type output ports

Project		Relay output port
External power supply		250Vac, up to 30Vdc
Circuit insulation		Mechanical insulation of relays
Action instructions		LED illuminates when relay output contact is closed
Leakage current in open circuit		/
Minimum load		2mA/5Vdc
Maximum output current	Resistive loads	2A/1 point; total current less than 8A at 8 points on the common COM terminal
	Inductive loads	220Vac, 80VA
	Electric light loads	220Vac, 100W
Response time	OFF→ON	MAX 20ms
	ON→OFF	MAX 20ms

### 4.2 Electrical specification for transistor type output ports

Table 4-2 Electrical specifications for transistor type output ports

Project		Transistor output port
External power		5~24Vdc
Circuit insulation		Optocoupler insulation
Action instructions		LED lights up when the optocoupler is driven
Leakage current in open circuit		Less than 0.1mA/30Vdc
Minimum load		5mA (5~24Vdc)
Maximum output current	Resistive load	3A/1 point 8A/4 points 1.6A/8 points 0.1A increase in total current allowed for each additional point above 8 points
	Inductive load	24Vdc, 7.2W
	Electric light load	24Vdc, 1.5W
Response time	OFF→ON	MAX 0.5ms (100mA/24Vdc)
	ON→OFF	MAX 0.5ms (100mA/24Vdc)

### 4.3 Output connection example

Figure 4-1 shows how the main module VC1-1614MAR and the extension module VC-0808ENR are connected. Different output groups can be connected to different signal voltage circuits. Some output groups (e.g. Y1-COM0) can be connected to the 24Vdc circuit and powered by 24V/COM of this controller; some output groups (e.g. Y5-COM1) can be connected to the 5Vdc low voltage signal circuit; while other output groups (e.g. Y11, Y13, Y15, etc.) can be connected in the 220Vac AC voltage signal circuit. That is, different output groups can work on different voltage circuits.

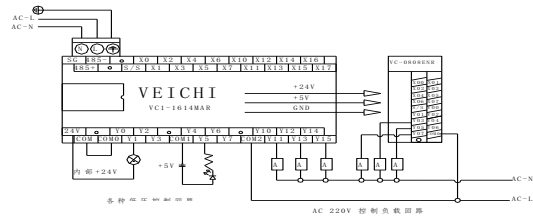

Figure 4-1 Example of the electrical connection between VC1-1614MAR and VC-0808ENR

## 5 Extended connection

### 5.1 Extension busbar connection

With the main module unpowered, remove the small cover of the expansion socket at the right end of the main module, then toggle the sliding catch of the main module upwards to the top, at this time plug the male socket of the expansion module, align it with the female socket of the expansion of the main module and push it in to the left, when finished, toggle the sliding catch downwards to the bottom to complete the connection of the expansion module. If more than one expansion module is connected, they can be connected one by one in turn. Please note that the small cover plate of the expansion socket is a detachable part to prevent loss during removal

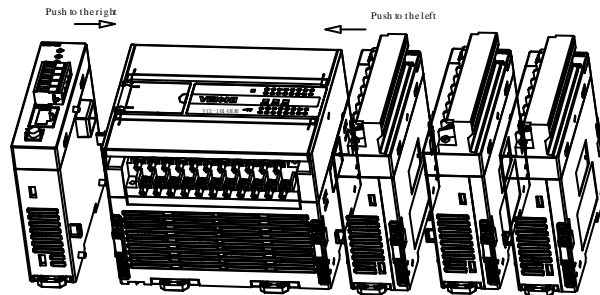

Figure 5-1 Extension module cascading method

### 5.2 Extension module addressing

The VC series PLCs can automatically identify and sequentially address the connected expansion modules without user intervention.

The automatic addressing operation is carried out once after the power is normally applied, and the address of each expansion module remains unchanged during operation thereafter. During the operation of the PLC, the I/O expansion modules and special function modules must not be plugged in or unplugged to avoid damaging the PLC or causing abnormal operation.

I/O point numbering using octal coding scheme, numbering such as: 0, 1, 2, 3, 4, 5, 6, 7, 10, 11, 12, 13, 14, 15, 16, 17, 20, 21, ..., no number 8, 9.



The input ports of the main module and I/O expansion modules are numbered X0, X1, X2, ... X7, X10, X11, ... and the output ports are numbered Y0, Y1, Y2, ... Y7, Y10, Y11, ..., and the numbers are arranged in this order. The points are numbered in groups of 8 and any part with less than 8 points will be left blank.

For example, if the VC1-1410MAR module has 14 input points, the terminals numbered X0 to X15 and X16 to X17 will not exist, and the X terminals of subsequent expansion modules will be numbered from X20 onwards; similarly, if the output points are 10, the terminals numbered Y0 to Y11 and Y12 to Y17 will not exist, and the Y terminals of subsequent expansion modules will be numbered from Y20 onwards.

I/O expansion modules are numbered in increasing order according to the order of connection to the main module's expansion, corresponding to the X and Y terminals.

An example of the logical numbering of the ports of the main module and the I/O expansion modules is as follows.

VC1-1410MAR	VC-0808ENT	VC-1600ENR	VC-0016ENT	VC-0808ENR
X0 ~ X15	X20 ~ X27	X30 ~ X37	Y30 ~ Y37	X50 ~ X57
Y0 ~ Y11	Y20 ~ Y27	X40 ~ X47	Y40 ~ Y47	Y50 ~ Y57

## 6 Installation

### 6.1 Size specification

The I/O expansion modules are available in five models: VC-0808ENR, VC-0808ENT, VC-1600ENR, VC-0016ENR and VC-0016ENT, whose external dimensions and mounting hole dimensions are shown in Figure 6-1.

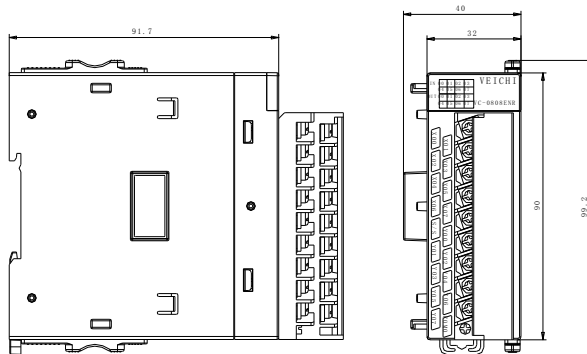

Figure 6-1 I/O expansion module external dimensions and mounting hole dimensions (unit: mm)

### 6.2 Installation method

The installation method is the same as that for the main module, please refer to the VC Series Programmable Controllers User Manual for details. An illustration of the installation is shown in Figure 6-2.

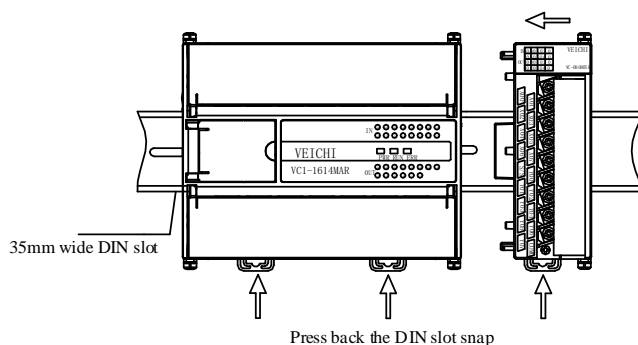

Fig. 6-2 Fixing with DIN slot

## 7 Operational check

### 7.1 Routine checks

1. Check that the analogue input/output wiring meets the requirements (see Figure 3-1 and Figure 4-1 for wiring instructions).
2. Check that the VC-I/O expansion module interface is reliably plugged into the expansion interface.
3. Check that the 5V and 24V power supplies are not overloaded. Note: The power supply for the VC-I/O expansion module section comes from the main module and is supplied through the expansion interface.
4. Set the VC main module to RUN status.

### 7.2 Fault checking

If the VC-I/O expansion module does not operate properly, check the following items.

1. Check that the VC-I/O expansion module interface is reliably plugged into the expansion interface.
2. Check whether the I/O expansion modules are correctly connected by monitoring the PLC information via the host software.
3. Check whether the total number of I/O expansion modules connected exceeds the specification maximum number of 15. (Total number = special module + I/O expansion module).
4. whether the VC main module is in normal operation.

### For Users

1. The scope of the warranty refers to the programmable controller body.
2. The warranty period is eighteen months. If the product fails or is damaged during the warranty period under normal use, we will repair it free of charge.
3. The start of the warranty period is the date of manufacture of the product, the machine code is the only basis for determining the warranty period, equipment without the machine code is treated as out of warranty.
4. Even within the warranty period, a repair fee will be charged for the following cases.  
failure of the machine due to non-operation in accordance with the user manual.  
Damage to the machine caused by fire, flooding, abnormal voltage, etc..  
Damage caused when using the programmable controller for a function other than its normal function.
5. The service charge will be calculated on the basis of the actual cost, and if there is another contract, the contract will take precedence.
6. Please make sure that you keep this card and present it to the service unit at the time of warranty.
7. If you have a problem, you can contact your agent or you can contact us directly.

Suzhou VEICHI Electric Technology Co., Ltd

China Customer Service Center

Address: No. 1000, Songjia Road, Wuzhong Economic and Technological Development Zone

Tel: 0512-66171988 Fax: 0512-6617-3610

Service hotline: 400-600-0303 website: www.veichi.com com

Data version v1 0 filed on July 30, 2021

All rights reserved. The contents are subject to change without notice.

## VEICHI Product Warranty Card

<b>Customer Information</b>	<b>Company address:</b>	
	<b>Company name:</b>	<b>contacts:</b>
		<b>contact number:</b>
<b>Product information</b>	<b>Product model:</b>	
	<b>Body barcode:</b>	
	<b>Name of agent:</b>	
<b>Fault information</b>	<b>Maintenance time and content:</b>	
	<b>Repairer:</b>	
<b>Maintenance time and content: Repairer:</b>	<b>Suzhou VEICHI Electric Technology Co., Ltd</b>	
	<b>Address: No. 1000, Songjia Road, Wuzhong Economic and Technological Development Zone</b>	